

TW: Through wall  
DH: Duct hung

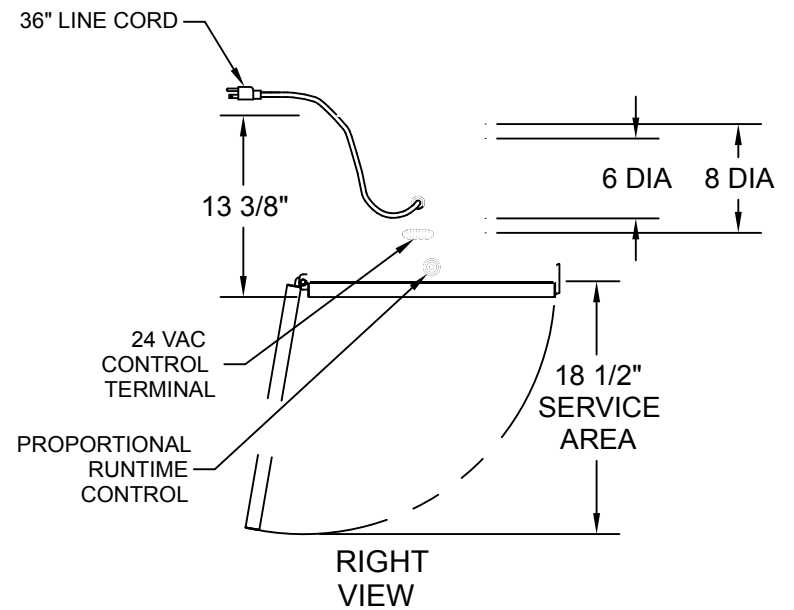

EA: Exhaust Air to outside  
OA: Outside Air intake  
RA: Room Air to be exhausted  
FA: Fresh Air to inside

Customer Approvals

Scale: 1" = 14"  
Do not scale drawing

BR130 Dimensions

RenewAire LLC

BR130DIMSMAY10